

STANDARD EQUIPMENT

ISO Standard cabin
All-weather steel cab with 360° visibility
Safety glass windows
Rise-up type windshield wiper
Sliding fold-in front window
Sliding side window(LH)
Lockable door
Hot & cool box
Storage compartment & Ashtray
Transparent cabin roof-cover
CD/MP3 Player
Handsfree mobile phone system with USB
Sun visor
Computer aided power optimization (New CAPO) system
3-power mode, 3-work mode, user mode
Auto deceleration & one-touch deceleration system
Auto warm-up system
Auto overheat prevention system
Automatic climate control
Air conditioner & heater
Defroster
Self-diagnostics system
Starting Aid (air grid heater) for cold weather
Centralized monitoring
LCD display
Engine speed or Trip meter/Accel.
Clock
Gauges
Fuel level gauge
Engine coolant temperature gauge
Hyd. oil temperature gauge
Warnings
Check Engine
Overload
Communication error
Low battery
Air cleaner clogging
Indicators
Max power
Low speed/High speed
Fuel warmer
Auto idle
Door and cab locks, one key
Two outside rearview mirrors
Fully adjustable suspension seat with seat belt
Pilot-operated slidable joystick
Console box height adjust system
Two front working lights
Electric horn
Batteries (2 x 12V x 100 AH)
Battery master switch
Removable clean-out screen for cooler
Automatic swing brake
Removable reservoir tank
Fuel pre-filter with fuel warmer
Boom holding system
Arm holding system
Counterweight (1,800kg, 3,970lb)
Accumulator for lowering work equipment
Electric Transducers
Lower frame under cover (Normal)
Viscous fan clutch
Rear-blade (550mm X 2,500mm)
Tires-dual (9.00-20-14PR)
Travel alarm

OPTIONAL EQUIPMENT

Fuel filler pump (35 L/min)
Beacon lamp
Safety lock valve for boom cylinder with overload warning device
Safety lock valve for arm cylinder
Single-acting piping kit (breaker, etc.)
Double-acting piping kit (clamshell, etc.)
Quick coupler
12 volt power outlet (24V DC to 12V DC converter)
Booms
4.6m, 15' 1"
4.9m, 16' 1" Hyd. adjustable boom
Arms
1.9m, 6' 3"
2.1m, 6' 11"
2.5m, 8' 2"
3.0m, 9' 10"
Bucket
0.23m³, 0.30yd³
0.40m³, 0.52yd³
0.46m³, 0.60yd³
0.52m³, 0.68yd³
0.58m³, 0.76yd³
0.65m³, 0.85yd³
0.71m³, 0.93yd³
0.45m³, 0.59yd³ Ditching bucket
0.55m³, 0.72yd³ Slope finishing bucket
Climate control
Air conditioner only
Heater only
Cabin FOPS/FOG (ISO/DIS 10262)
FOPS (Falling Object Protective Structure)
FOG (Falling Object Guard)
Cabin roof-steel cover
Cabin front guard-wire net
Cabin lights
Cabin front window rain guard
Undercarriage
Rear outrigger
Rear dozer and front outrigger
Rear and front outrigger
Rear outrigger and front dozer
Lower frame under cover (Additional)
Tool kit
Operator suit
Rearview camera
Seat
Adjustable air suspension seat
Adjustable air suspension seat with heater
Mechanical suspension seat with heater
Tiers - dual (9.00 - 20 solid)
Pattern change valve (2 patterns)
Hi-mate (Remote Management System)

Standard and optional equipment may vary. Contact your Hyundai dealer for more information. The machine may vary according to International standards. All imperial measurements rounded off to the nearest pound or inch.

PLEASE CONTACT

HYUNDAI HEAVY INDUSTRIES CO., LTD. **CONSTRUCTION EQUIPMENT**

Head Office (Sales Office)
1 JEONHA-DONG, DONG-GU, ULSAN, KOREA TEL: (82) 52-202-7970, 7729, 0971 FAX: (82) 52-202-7979, 7720

U.S. Operation: Hyundai Construction Equipment U.S.A., Inc.
955 ESTES AVENUE, ELK GROVE VILLAGE, IL. 60007, U.S.A. TEL: (1) 847-437-3333 FAX: (1) 847-437-3574

European Operation: Hyundai Heavy Industries Europe N.V.
VOSSENDAAL 11, 2440 GEEL, BELGIUM TEL: (32) 14-56-2200 FAX: (32) 14-59-3405

India Operation: Hyundai Construction Equipment India Pvt., Ltd.
PLOT NO.A-2, CHAKAN INDUSTRIAL AREA, VILL.- KHALUMBRE. TALUK.- KHED., DIST.- PUNE 410 501, INDIA
TEL: (91) 21-3530-1700 FAX: (91) 21-3530-1712

We build a better future

Robex
140w-9

With Tier 3 Engine installed



*Photo may include optional equipment.

Pride at Work

Hyundai Heavy Industries strives to build state-of-the-art earthmoving equipment to give every operator maximum performance, more precision, versatile machine preferences, and proven quality. Take pride in your work with a Hyundai!



Robex 140w-9

Machine Walk-Around

Carrier

Heavy duty carrier frame with two speed powershift transmission
Heavy duty drive line and axles
Front axle oscillation +/- 7 degrees with ram lock
Wet disc brake with no digging effect (front & rear)
Automatic parking brake - spring applied, hydraulically released

Engine Technology

Proven and reliable, fuel efficient Cummins Tier III QSB6.7 engine
Electronically controlled for optimum fuel-to-air ratio and clean, efficient combustion
Low noise / Auto engine overheat feature / Anti-restart feature

Hydraulic System Improvements

New patented hydraulic control system for improved controllability / Improved control valve design for added efficiency and smoother operation / New auto boom and swing priority system for optimum speed / New auto power boost feature for additional power when needed / Improved arm-in flow regeneration system for added speed and efficiency

Pump Compartment

Industry-leading, powerful, reliable Kawasaki designed, variable volume in-line axial piston pumps
New compact solenoid block equipped with 3 solenoid valves, 2 EPPR valves, 1 check valve accumulator and pilot filter - controls 2 speed travel, power boost, boom priority, safety lock, arm-in regeneration control, swing logic valve control
Remotely mounted fuel, engine oil and case drain filters for maximum convenience while servicing

Improved Steering Column

Slim-profile steering column capable of telescoping 60 mm and tilting 30 degrees

Enhanced Operator Cab

Improved visibility

Enlarged cab with improved visibility / See-through upper skylight for visibility and ventilation
Larger right-side glass, now one piece, for better right visibility
Safety glass windows on all sides - less expensive than (polycarbonate) and won't scratch or fade
Closeable sunshade for operator convenience / Reduced front window seam for improved operator view

Improved Cab Construction

New steel tube construction for added operator safety, protection and durability
New window open/close mechanism designed with cable and spring lift assist and single latch release

Improved Suspension Seat / Console Assembly

Ergonomic joysticks with auxiliary control buttons for attachment use. Now with new sleek styling
Heated suspension (standard) or optional air ride suspension with heat
New joystick consoles - now adjustable in height by way of dial at bottom
Adjustable arm rests - turn dial to raise or lower for optimum comfort

Advanced 7" Color Cluster

New color LCD display with easy-to-read digital gauges for hydraulic oil temperature, water temperature, and fuel
Simplified design makes adjustment and diagnostics easier. Also, new enhanced features such as rear-view camera are integrated into monitor.

3 power modes : (P) Power, (S) Standard, (E) Economy, 3 work modes : Dig, Breaker, Crusher, (U) User mode for operator preference
Enhanced self-diagnostic features with GPS download capability
One pump flow or two pump flow for optional attachment now selectable through the cluster / New anti-theft system with password capability
Boom speed and arm regeneration are selectable through the monitor.
Auto power boost is now available - selectable (on/off) through the monitor.
Powerful air conditioning and heat with auto climate control, 20% more heat and air output than 7A series!
Hi-Mate (Remote Management System) works through GPS/Satellite technology to ultimately provide better customer service and support.

Preference

Operating a 9 series is unique to every operator. Operators can fully customize their work environment and operating preferences to fit their individual needs.



*Photo may include optional equipment.



Wide Cabin with Excellent Visibility

The newly designed cabin was conceived for more space, a wider field of view and operator comfort. Special attention was given to a clear, open and convenient interior with plenty of visibility on the machine surroundings and the job at hand. This well balanced combination of precision aspects put the operator in the perfect position to work safely and securely.

Operator Comfort

In a 9 series cabin you can easily adjust the seat, console and armrest settings to best suit your preferred comfort level. Seat and console position and height can be set together and independent from each other. Improved steering wheel telescope and tilt functions provide operators improved access. A fully automatic, high capacity airconditioning system maintains a constant preferred temperature. During cold weather conditions, the PTC cab heater provides immediate heat at startup for added operator comfort.



Reduced Stress

Work is stressful enough. Your work environment should be stress free. Hyundai's 9 series provides improved cab amenities, additional space and a comfortable seat to minimize stress to the operator. A powerful climate control system provides the operator with optimum air temperature. An advanced audio system with CD player, AM/FM stereo and MP3 capabilities, plus remotely located controls is perfect for listening to music favorites. Operators can even talk on the phone with the hands-free cell phone feature.



Operator - Friendly Cluster

The advanced new cluster with 7 inch wide color LCD screen and toggle switch allows the operator to select his personal machine preferences. Power and work mode selection, self diagnostics, optional rear-view camera, maintenance check lists, start-up machine security, and video functions were integrated into the cluster to make the machine more versatile and the operator more productive.



Precision

Innovative hydraulic system technologies make the 9 series excavator fast, smooth and easy to control.



Computer Aided Power

The engine horsepower and hydraulic horsepower work together in unison through the advanced CAPO(Computer Aided Power Optimization) system.

This system interfaces with multiple sensors placed throughout the hydraulic system as well as the electronically controlled engine to provide the optimum level of engine power and hydraulic flow for the job at hand.

Operators can set their own preferences for boom or swing priority, power mode selection and optional work tools at the touch of a button. The CAPO system also provides complete self diagnostic features and digital gauges for important information like hydraulic oil temperature, water temperatures and fuel level.

Power Mode

Three unique power modes provide the operator with custom power, speed and fuel economy. P (Power Max) mode maximizes machine speed and power for mass production.

S (Standard) mode provides a reduced, fixed rpm for optimum performance and improved fuel economy. For maximum fuel savings and improved control, E (Economy) mode provides precise flow and engine power based on load demand.

Work Mode

The work mode allows the operator to select single flow attachments like a hydraulic breaker or bi-directional flow attachments like a crusher. Flow settings unique to each attachment can be programmed from within the cluster.

User Mode

Some jobs require more precise machine settings. Using the versatile U (User) mode, the operator can customize engine speed, pump output, idle speed and other machine settings according to personal preferences.

Improved Hydraulic System



To achieve optimum precision, Hyundai redesigned the hydraulic system to provide the operator with super fine touch and improved controllability. Improved pump flow control reduces flow when controls are not being used to minimize fuel consumption.

Improved spool valves in the control valve are engineered to provide more precise flow to each function with less effort.

Improved hydraulic valves, precision-designed variable volume piston pumps, fine-touch pilot controls, and enhanced travel functions make any operator running a 9

series look like a smooth operator. Newly improved features include arm-in and boom-down flow regeneration, improved control valve technology and innovative auto boom and swing priority for optimal performance in any application.

Auto Boom-swing Priority

This smart function automatically and continuously looks for the ideal hydraulic flow balance for the boom and swing functions of the machine. The advanced CAPO system monitors the hydraulic system and adjusts its settings to maximize performance and productivity.



Performance

9 series is designed for maximum performance to keep the operator working productively.

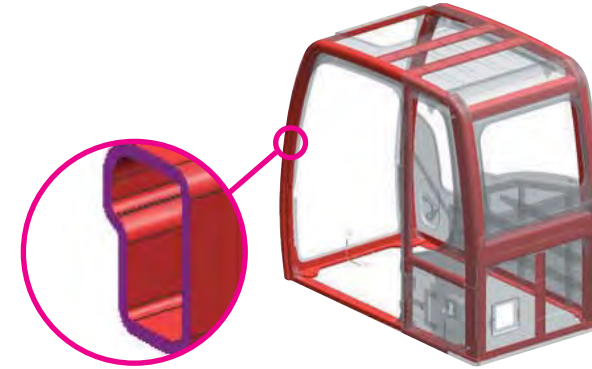

*Photo may include optional equipment.



Fully Independent Outrigger System

R140W-9 can be equipped with four independent outriggers (front and rear) or two independent outriggers and a dozer blade (front or rear). Each outrigger and the dozer blade are controlled by a switch and the dozer lever. Each outrigger is equipped with cylinder guards for added protection.



Structural Strength

The 9 series cabin structure has been fitted with stronger but slimmer tubing for more safety and better visibility. Low-stress and high strength steel was integrally welded to form a strong and stable lower frame. Structural durability was evaluated and tested by means of FEM (Finite Elements Method) analysis and long-term durability tests.

New and Improved Travel System

Auto cruise control system reduces operator fatigue by maintaining a fixed speed when driving distances. A new auto ram lock system is available to improve operating safety. A new creep speed travel system improves maneuverability and fine control. A new optional forward / reverse travel pedal control allows operators to choose to use the travel pedal control while in work mode or lever control when in travel mode.

CUMMINS QSB 6.7 Engine

The Tier III, six cylinder, 4 cycle, turbo-charged, charge air cooled, Cummins QSB 6.7 engine provides maximum power, reliability, optimum fuel economy, and reduced emissions. Electronically controlled fuel injection and diagnostic capabilities add to the engine's efficiency and serviceability.



Profitable

9 series is designed to maximize profitability through improved efficiencies, enhanced service features and longer life components.

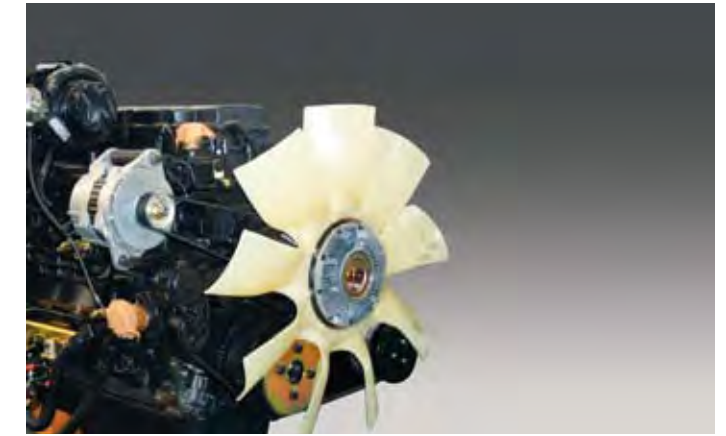

Fuel Efficient

9 series excavators are engineered to be extremely fuel efficient. New innovations like the variable speed fan clutch, overload prevention control, three-stage auto decel system, and the new economy mode, conserve fuel and reduce the impact on the environment.



Hi-mate (Remote Management System)

Hi-mate, Hyundai's proprietary remote management system, provides operators and dealer service personnel access to vital service and diagnostic information on the machine from any computer with internet access. Users can pinpoint machine location using digital mapping and set machine work boundaries. Hi-mate saves time and money for the owner and dealer by promoting preventative maintenance and reducing the need for multiple service calls.



Easy Access

Ground-line access to filters, lube fittings, fuses, machine computer components and wide open compartments makes service more convenient on the 9 series.

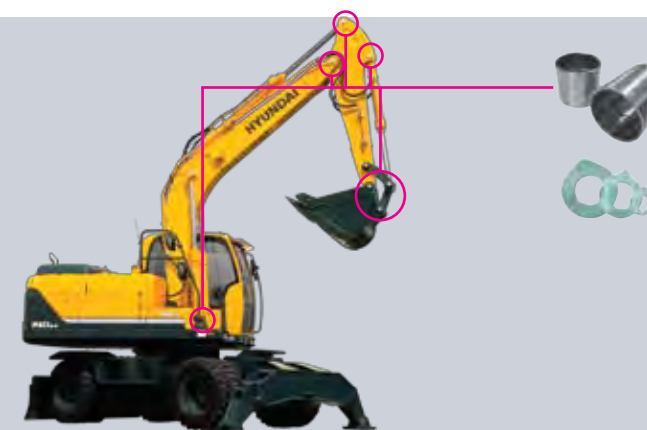

Extended Life Components

New long-life bushings are designed for extended lube intervals (250 hrs). Wear-resistant polymer shims reduce noise and wear of bushings. Extended-life hydraulic filters last up to 1,000 hrs and new long-life hydraulic oil need only be changed every 5,000 hrs. Improved cooling system components for better efficiency and longer service life.

*Photo may include optional equipment.

Specifications

ENGINE

MODEL		Cummins QSB 6.7	
Type		Water-cooled, 4-cycle diesel, 6-cylinder in-line, Direct injection, Turbocharged, Charge air cooled, Low emission	
Rated flywheel horsepower	SAE	J1995 (gross)	146 HP (109kW) at 2,100 rpm
		J1349 (net)	133 HP (99kW) at 2,100 rpm
Rated flywheel horsepower	DIN	6271/1 (gross)	148 PS (109kW) at 2,100 rpm
		6271/1 (net)	135 PS (99kW) at 2,100 rpm
Max. torque		59.7 kgf-m(432 lbf-ft) at 1,500 rpm	
Bore X stroke		107 x 124 mm (4.21" x 4.88")	
Piston displacement		6,700 cc (409 in³)	
Batteries		2 x 12 V x 100 AH	
Starting motor		24V-4.5kW	
Alternator		24V-50 Amp	

HYDRAULIC SYSTEM

MAIN PUMP	
Type	Two variable displacement piston pumps
Rated flow	2 X 168 L/min (44.5 US gpm/37 UK gpm)
Sub-pump for pilot circuit	Gear pump

Cross-sensing and fuel saving pump system

HYDRAULIC MOTORS

Travel	Two-speed axial pistons motor with brake valve and parking brake
Swing	Axial piston motor with automatic brake

RELIEF VALVE SETTING

Implement circuits	350 kgf/cm² (4,970 psi)
Travel	380 kgf/cm² (5,400 psi)
Power boost (boom, arm, bucket)	380 kgf/cm² (5,400 psi)
Swing circuit	285 kgf/cm² (4,050 psi)
Pilot circuit	40 kgf/cm² (570 psi)
Service valve	Installed

HYDRAULIC CYLINDERS

No. of cylinder bore X stroke	Boom : 2-105 x 1075 mm (4.1" x 42.3")
	Arm : 1-115 x 1188 mm (4.5" x 46.8")
	Bucket : 1-100 x 840 mm (3.9" x 33.1")
	Blade : 2-100 x 236 mm (3.9" x 9.3")
	Outrigger : 2-110 x 475 mm (4.9" x 18.7")
	2-PCS boom : 2-105 x 975mm (4.1" x 38.4")
Adjust(boom) : 1-145 x 613mm (5.7" x 24.1")	

DRIVES & BRAKES

4-wheel hydrostatic drive. Constant mesh, helical gear transmission provides 2 forward and reverse travel speeds.

Max. drawbar pull	8,500 kgf (18,740 lbf)	
Travel speed	1st	10 km/h
	2nd	37 km/h
Gradeability	35(70 %)	

Parking brake : Independent dual brake, front and rear axle full hydraulic power brake.

- Spring released and hydraulic applied wet type multiple disk brake.

- Transmission is locked at neutral position for parking, automatically.

CONTROL

Pilot pressure operated joysticks and pedals with detachable lever provide almost effortless and fatigueless operation.

Pilot control	Two joysticks with one safety lever (LH): Swing and arm, (RH): Boom and bucket (ISO)
Engine throttle	Electric, Dial type
Lights	Two lights mounted on the boom, one under the battery box and one under the cabin

AXLE & WHEEL

Full floating front axle is supported by center pin for oscillation. It can be locked by oscillation lock cylinders. Rear axle is fixed on the lower chassis.

Tires	9.00-20-14PR, Dual(tube type)
(optional)	9.00-20, Dual(solid type)

SWING SYSTEM

Swing motor	Two fixed displacement axial pistons motor
Swing reduction	Planetary gear reduction
Swing bearing lubrication	Grease-bathed
Swing brake(option)	Multi wet disc(pin lock type)
Swing speed	12.4 rpm

STEERING SYSTEM

Hydraulically actuated, orbitrol type steering system actuates on front wheels through the steering cylinders.

Min. turning radius	6,300 mm(20' 8")
---------------------	------------------

COOLANT & LUBRICANT CAPACITY

Re-filling	liter	US gal	UK gal	
Fuel tank	270	71.3	59.4	
Engine coolant	19.5	5.2	4.3	
Engine oil	24	6.3	5.3	
Swing device - gear oil	2.5	0.7	0.5	
Axle	Front	13.3	3.5	2.9
	Rear	16.1	4.3	3.5
Hydraulic system (including tank)	210	55.5	46.2	
Hydraulic tank	124	32.8	27.3	

UNDERCARRIAGE

Reinforced box-section frame is all-welded, low-stress.

Dozer blade and outriggers are available. A pin-on design.

Dozer blade	A very useful addition for leveling and back filling or clean-up work.
Outrigger	Indicated for max. operation stability when digging and lifting. Can be mounted on the front/or the rear.

OPERATING WEIGHT (APPROXIMATE)

Operating weight, including 4,600mm (15' 1") One-piece boom, 2,100mm (6' 11") arm, SAE heaped 0.58 m³ (0.76 yd³) backhoe bucket, lubricant, coolant, full fuel tank, hydraulic tank and the standard equipment.

MAJOR COMPONENT WEIGHT

Upperstructure	4,680kg (10,320 lb)	
Counterweight	1,800kg (3,970 lb)	
Mono boom(with arm cylinder)	1,030kg (2,270 lb)	
Hydraulic adjustable boom (with adjust cylinder and arm cylinder)	1,430kg (3,150 lb)	

OPERATING WEIGHT

Undercarriage	Mono boom	Hyd. adjustable boom
Rear dozer blade	13,700 (30,200)	14,100 (31,090)
Rear outrigger	14,100 (31,090)	14,500 (31,970)
Front outrigger and rear blade	14,700 (32,410)	15,100 (33,290)
Front blade and rear outrigger	14,700 (32,410)	15,100 (33,290)
Four outrigger	15,100 (33,290)	15,500 (34,170)

BUCKETS

All buckets are welded with high-strength steel.

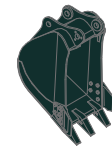

0.23 (0.30)

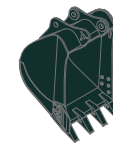

0.40 (0.52)
0.46 (0.60)

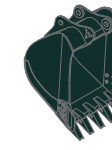

0.52 (0.68)
0.58 (0.76)



0.65 (0.85)

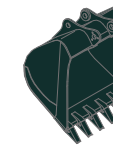

0.71 (0.93)

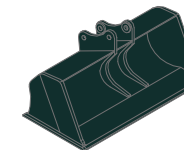

■ 0.45 (0.59)



● 0.55 (0.72)

SAE heaped m³ (yd³)

Capacity m³ (yd³)	Width mm (in)	Weight kg (lb)	Recommendation m (ft-in)								
			4.6 (15' 1") Boom				4.9 (16' 1") Boom				
			1.9 (6' 3") Arm	2.1 (6' 11") Arm	2.5 (8' 2") Arm	3.0 (9' 10") Arm	1.9 (6' 3") Arm	2.1 (6' 11") Arm	2.5 (8' 2") Arm		
0.23 (0.30)	0.20(0.26)	520(20.5)	620(24.4)	335(740)	●	●	●	■	●	●	●
0.40 (0.52)	0.35(0.46)	750(29.5)	850(33.5)	410(900)	●	●	●	■	●	●	●
0.46 (0.60)	0.40(0.52)	840(33.1)	940(37.0)	435(960)	●	●	■	▲	●	●	■
0.52 (0.68)	0.45(0.59)	915(36.0)	1,015(40.0)	460(1,010)	●	■	■	-	●	■	■
0.58 (0.76)	0.50(0.65)	1,000(39.4)	1,100(43.3)	480(1,060)	●	■	▲	-	■	▲	▲
0.65 (0.85)	0.55(0.72)	1,105(43.5)	1,205(47.4)	500(1,100)	■	▲	-	-	▲	▲	-
0.71 (0.93)	0.60(0.78)	1,190(46.9)	1,290(50.8)	540(1,190)	▲	▲	-	-	▲	-	-
■ 0.45 (0.59)	0.40(0.52)	1,520(59.8)	1,620(63.8)	410(900)	●	●	■	-	■	■	▲
● 0.55 (0.72)	0.45(0.59)	1,800(70.9)	1,900(74.8)	585(1,290)	■	▲	▲	-	■	▲	▲

■ Ditching bucket

● Slope finishing bucket

●: Applicable for materials with density of 2,000 kg /m³ (3,370 lb/ yd³) or less

■: Applicable for materials with density of 1,600 kg /m³ (2,700 lb/ yd³) or less

▲: Applicable for materials with density of 1,100 kg /m³ (1,850 lb/ yd³) or less

ATTACHMENT

Booms and arms are welded with a low-stress, full-box section design. 4.6m & 4.9m Booms and 1.9m, 2.1m, 2.5m, & 3.0m Arms are available.

DIGGING FORCE

Boom	Length	mm (ft-in)	4,600 (15' 1")				Remarks
			Weight	kg (lb)			
Arm	Length	mm (ft-in)	1,900 (6' 3")		2,100 (6' 11")		
			2,500 (8' 2")		3,000 (9' 10")		
Bucket digging force	Weight	kg (lb)	560 (1,230)		580 (1,280)		
			610 (1,340)		670 (1,480)		
Arm crowd force	SAE	kN	87.3 [94.8]	87.3 [94.8]	87.3 [94.8]	87.3 [94.8]	[]: Power Boost
		kgf	8,900 [9,660]	8,900 [9,660]	8,900 [9,660]	8,900 [9,660]	
		lbf	19,620 [21,300]	19,620 [21,300]	19,620 [21,300]	19,620 [21,300]	
	ISO	kN	102 [110.8]	102 [110.8]	102 [110.8]	102 [110.8]	
		kgf	10,400 [11,290]	10,400 [11,290]	10,400 [11,290]	10,400 [11,290]	
		lbf	22,930 [24,890]	22,930 [24,890]	22,930 [24,890]	22,930 [24,890]	
SAE	kN	76.5 [83.1]	73.6 [79.9]	62.8 [68.2]	55.9 [60.7]		
	kgf	7,800 [8,470]	7,500 [8,140]	6,400 [6,950]	5,700 [6,190]		
	lbf	17,200 [18,670]	16,530 [17,950]	14,110 [15,320]	12,570 [13,640]		
ISO	kN	80.4 [87.3]	77.5 [84.1]	65.7 [71.4]	57.9 [62.8]		
	kgf	8,200 [8,900]	7,900 [8,580]	6,700 [7,270]	5,900 [6,410]		
	lbf	18,080 [19,630]	17,420 [18,910]	14,770 [16,040]	13,010 [14,120]		

Note: Boom weight includes arm cylinder, piping, and pin

Arm weight includes bucket cylinder, linkage, and pin

Dimensions & Working Range

R140W-9 DIMENSIONS

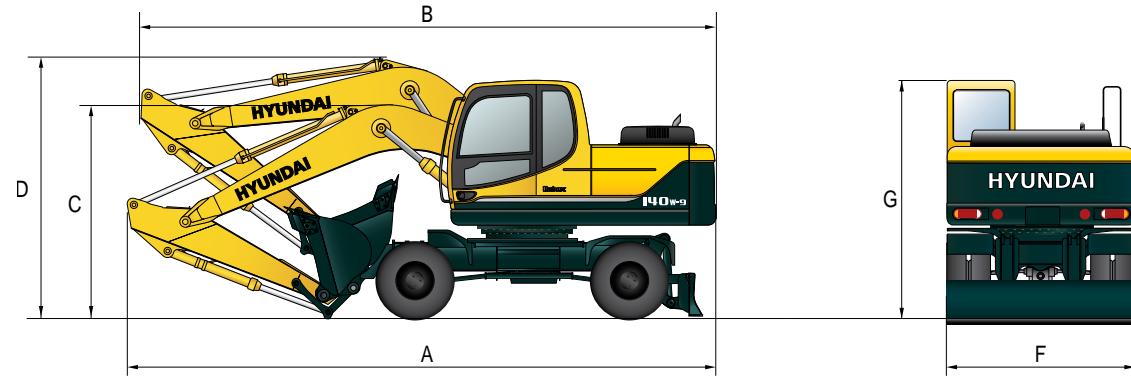

Unit : mm (ft · in)

Mono Boom	4,600(15' 1")			
Arm	1,900 (6' 3")	2,100 (6' 11")	2,500 (8' 2")	3,000 (9' 10")
A Overall length of shipping position	7,760 (25' 6")	7,820 (25' 8")	7,770 (25' 6")	7,830 (25' 8")
B Overall length of traveling position	7,750 (25' 5")	7,760 (25' 6")	7,690 (25' 3")	7,710 (25' 4")
C Height of attachment(shipping position)	2,760 (9' 1")	2,860 (9' 5")	2,810 (9' 3")	3,100 (10' 2")
D Height of attachment(traveling position)	3,500 (11' 6")	3,500 (11' 6")	3,620 (11' 11")	3,600 (11' 10")
F Overall width	2,500 (8' 2")	2,500 (8' 2")	2,500 (8' 2")	2,500 (8' 2")
G Height of cabin	3,140 (10' 4")	3,140 (10' 4")	3,140 (10' 4")	3,140 (10' 4")

R140W-9 WORKING RANGE

Unit : mm (ft · in)

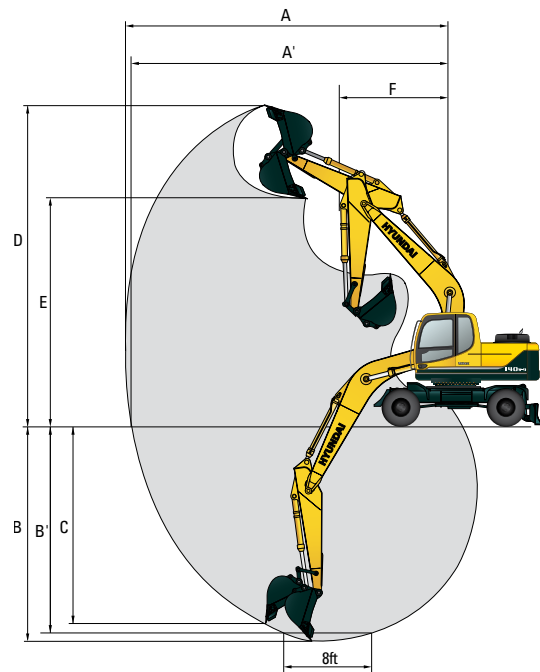

Boom length	4,600 (15' 1")			
Arm length	1,900 (6' 3")	2,100 (6' 11")	2,500 (8' 2")	3,000 (9' 10")
A Max. digging reach	7,750 (25' 5")	7,920 (26' 0")	8,320 (27' 4")	8,780 (28' 10")
A' Max. digging reach on ground	7,530 (24' 8")	7,700 (25' 3")	8,120 (26' 8")	8,590 (28' 2")
B Max. digging depth	4,650 (15' 3")	4,850 (15' 11")	5,250 (17' 3")	5,750 (18' 10")
B' Max. digging depth (8' level)	4,390 (14' 5")	4,600 (15' 1")	5,040 (16' 6")	5,570 (18' 3")
C Max. vertical wall digging depth	4,350 (14' 3")	4,460 (14' 8")	5,030 (16' 6")	5,550 (18' 3")
D Max. digging height	8,400 (27' 7")	8,470 (27' 9")	8,790 (28' 10")	9,070 (29' 9")
E Max. dumping height	5,960 (19' 7")	6,040 (19' 10")	6,350 (20' 10")	6,620 (21' 9")
F Min. swing radius	2,620 (8' 7")	2,670 (8' 10")	2,650 (8' 8")	2,670 (8' 9")

Dimensions & Working Range

R140W-9 ADJUSTABLE BOOM

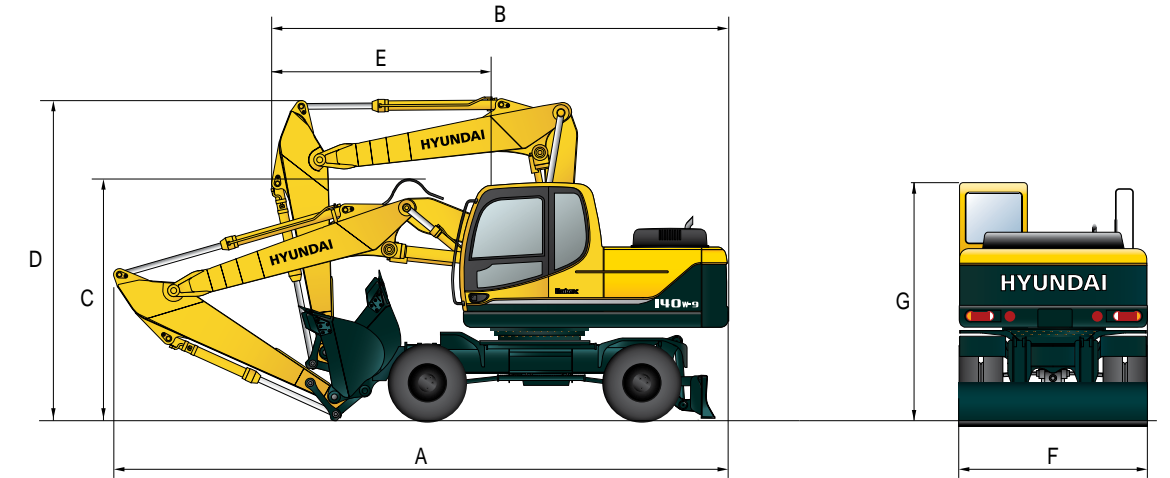

Unit : mm (ft · in)

Hydraulic adjustable Boom	4900(16' 1")		
Arm	1,900 (6' 3")	2,100 (6' 11")	2,500 (8' 2")
A Overall length of shipping position	8,140 (26' 8")	8,170 (26' 10")	8,150 (26' 9")
B Overall length of traveling position	6,090 (19' 12")	6,110 (20' 1")	6,130 (20' 1")
C Height of attachment(shipping position)	2,960 (9' 9")	3,060 (10' 0")	3,070 (10' 1")
D Height of attachment(traveling position)	3,980 (13' 1")	3,980 (13' 1")	3,980 (13' 1")
E End of attachment to steering wheel	2,950 (9' 8")	2,970 (9' 9")	2,990 (9' 10")
F Overall width	2,500 (8' 2")	2,500 (8' 2")	2,500 (8' 2")
G Height of cabin	3,140 (10' 4")	3,140 (10' 4")	3,140 (10' 4")

R140W-9 ADJUSTABLE BOOM WORKING RANGE

Unit : mm (ft · in)

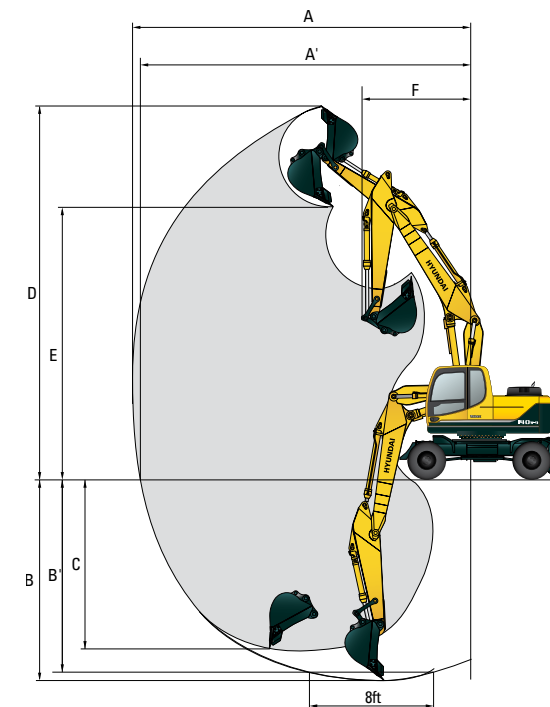

Boom length	4,900 (16' 1")		
Arm length	1,900 (6' 3")	2,100 (6' 11")	2,500 (8' 2")
A Max. digging reach	8,140 (26' 8")	8,310 (27' 3")	8,720 (28' 7")
A' Max. digging reach on ground	7,930 (26' 0")	8,110 (26' 7")	8,530 (28' 0")
B Max. digging depth	4,810 (15' 9")	5,010 (16' 5")	5,410 (17' 9")
B' Max. digging depth (8' level)	4,700 (15' 5")	4,890 (16' 1")	5,310 (17' 5")
C Max. vertical wall digging depth	4,190 (13' 9")	4,360 (14' 4")	4,820 (15' 10")
D Max. digging height	9,100 (29' 10")	9,180 (30' 1")	9,560 (31' 4")
E Max. dumping height	6,620 (21' 9")	6,700 (22' 0")	7,070 (23' 2")
F Min. swing radius	2,660 (8' 9")	2,820 (9' 3")	2,690 (8' 10")

Undercarriage

Lifting Capacity

R140W-9 MONO BOOM

Rating over-front Rating over-side or 360 degree

Boom : 4.6 m (15' 1") / Arm : 1.9 m (6' 3") / Bucket : 0.58 m³ (0.76 yd³) SAE heaped / With rear dozer blade down and 1,800kg Counterweight

Load point height m (ft)	Load radius								At max. reach			
	1.5 m (5.0 ft)		3.0 m (10.0 ft)		4.5 m (15.0 ft)		6.0 m (20.0 ft)		Capacity	Reach		
6.0 m (20.0 ft)	kg					*3350	*3350			*3200	2080	6.22
	lb					*7390	*7390			*7050	4590	(20.4)
4.5 m (15.0 ft)	kg					*3740	3550	*2860	2120	*3310	1610	7.05
	lb					*8250	7830	*6310	4670	*7300	3550	(23.1)
3.0 m (10.0 ft)	kg			*7070	6400	*4710	3330	*3900	2050	3370	1420	7.42
	lb			*15590	14110	*10380	7340	*8600	4520	7430	3130	(24.3)
1.5 m (5.0 ft)	kg			*7620	5740	*5750	3090	*4340	1960	3320	1380	7.42
	lb			*16800	12650	*12680	6810	*9570	4320	7320	3040	(24.3)
Ground	kg			*8960	5590	*6340	2940	*4600	1890	3590	1480	7.06
Line	lb			*19750	12320	*13980	6480	*10140	4170	7910	3260	(23.2)
-1.5 m (-5.0 ft)	kg	*7690	*7690	*9450	5620	*6250	2920			*3860	1830	6.24
	lb	*16950	*16950	*20830	12390	*13780	6440			*8510	4030	(20.5)
-3.0 m (-10.0 ft)	kg			*7750	5800	*5020	3030					
	lb			*17090	12790	*11070	6680					

Boom : 4.6 m (15' 1") / Arm : 2.1 m (6' 11") / Bucket : 0.58 m³ (0.76 yd³) SAE heaped / With rear dozer blade down and 1,800kg Counterweight

Load point height m (ft)	Load radius								At max. reach			
	1.5 m (5.0 ft)		3.0 m (10.0 ft)		4.5 m (15.0 ft)		6.0 m (20.0 ft)		Capacity	Reach		
6.0 m (20.0 ft)	kg					*3130	*3130			*3050	1950	6.43
	lb					*6900	*6900			*6720	4300	(21.1)
4.5 m (15.0 ft)	kg					*3540	*3540	*3210	2120	*3160	1520	7.23
	lb					*7800	*7800	*7080	4670	*6970	3350	(23.7)
3.0 m (10.0 ft)	kg			*6620	6450	*4510	3310	*3770	2040	3230	1340	7.59
	lb			*14590	14220	*9940	7300	*8310	4500	7120	2950	(24.9)
1.5 m (5.0 ft)	kg			*8650	5730	*5580	3060	*4230	1930	3180	1300	7.59
	lb			*19070	12630	*12300	6750	*9330	4250	7010	2870	(24.9)
Ground	kg			*9090	5510	*6240	2900	*4540	1860	3420	1390	7.24
Line	lb			*20040	12150	*13760	6390	*10010	4100	7540	3060	(23.8)
-1.5 m (-5.0 ft)	kg	*7380	*7380	*9530	5530	*6240	2860			*3760	1700	6.45
	lb	*16270	*16270	*21010	12190	*13760	6310			*8290	3750	(21.2)
-3.0 m (-10.0 ft)	kg	*11710	*11710	*7990	5690	*5240	2950					
	lb	*25820	*25820	*17610	12540	*11550	6500					

Boom : 4.6 m (15' 1") / Arm : 2.5 m (8' 2") / Bucket : 0.58 m³ (0.76 yd³) SAE heaped / With rear dozer blade down and 1,800kg Counterweight

Load point height m (ft)	Load radius								At max. reach			
	1.5 m (5.0 ft)		3.0 m (10.0 ft)		4.5 m (15.0 ft)		6.0 m (20.0 ft)		Capacity	Reach		
6.0 m (20.0 ft)	kg									*2820	1700	6.92
	lb									*6220	3750	(22.7)
4.5 m (15.0 ft)	kg					*3110	*3110	*2980	2150	*2880	1360	7.66
	lb					*6860	*6860	*6570	4740	*6350	3000	(25.1)
3.0 m (10.0 ft)	kg			*5700	*5700	*4110	3360	*3500	2050	*2930	1200	8.00
	lb			*12570	*12570	*9060	7410	*7720	4520	*6460	2650	(26.2)
1.5 m (5.0 ft)	kg			*8610	5850	*5270	3080	*4030	1930	2900	1160	8.00
	lb			*18980	12900	*11620	6790	*8880	4250	6390	2560	(26.2)
Ground	kg	*3820	*3820	*9000	5500	*6070	2890	*4430	1830	3090	1240	7.67
Line	lb	*8420	*8420	*19840	12130	*13380	6370	*9770	4030	6810	2730	(25.2)
-1.5 m (-5.0 ft)	kg	*6470	*6470	*9740	5460	*6260	2820	*4470	1800	*3510	1480	6.94
	lb	*14260	*14260	*21470	12040	*13800	6220	*9850	3970	*7740	3260	(22.8)
-3.0 m (-10.0 ft)	kg	*9750	*9750	*8560	5580	*5620	2870			*3480	2150	5.64
	lb	*21500	*21500	*18870	12300	*12390	6330			*7670	4740	(18.5)

1. Lifting capacity is based on SAE J1097, ISO 10567.
 2. Lifting capacity of the Robex Series does not exceed 75% of the tipping load with the machine on firm, level ground or 87% of full hydraulic capacity.
 3. The load point is a hook located on the back of the bucket.
 4. (*) indicates the load limited by hydraulic capacity.

R140W-9 WITH REAR DOZER

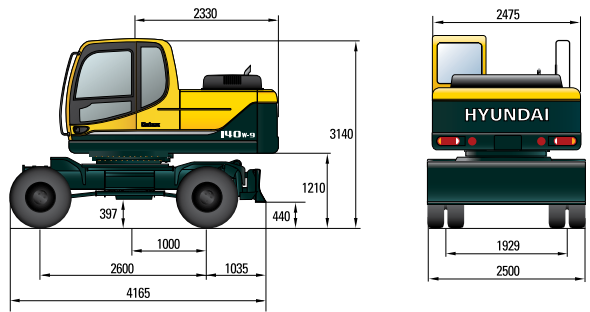

R140W-9 WITH REAR OUTRIGGER

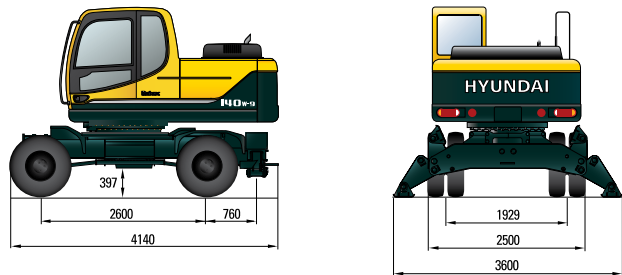

R140W-9 WITH REAR DOZER AND FRONT OUTRIGGER

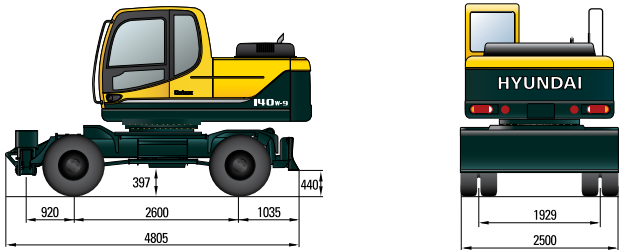

R140W-9 WITH REAR AND FRONT OUTRIGGER

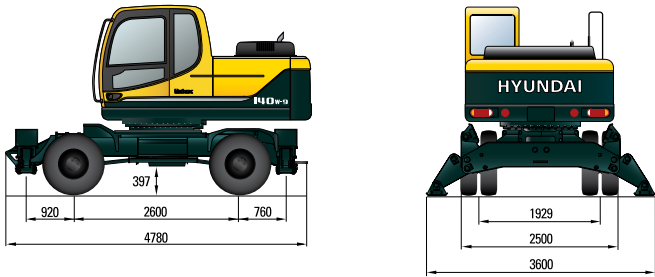

R140W-9 WITH REAR OUTRIGGER AND FRONT DOZER

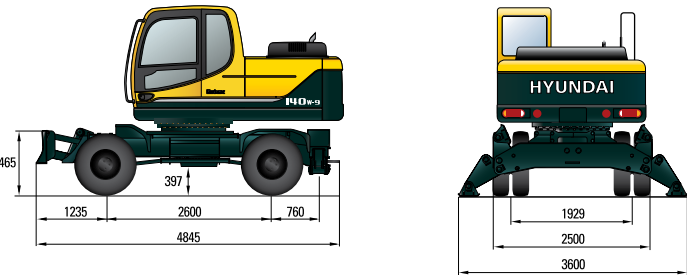













Lifting Capacity

R140W-9 MONO BOOM

 Rating over-front  Rating over-side or 360 degree







Boom : 4.6 m (15' 1") / Arm : 3.0 m (9' 10") / Bucket : 0.58 m³ (0.76 yd³) SAE heaped / With rear dozer blade down and 1,800kg Counterweight

Load point height m (ft)	Load radius								At max. reach					
	1.5 m (5.0 ft)		3.0 m (10.0 ft)		4.5 m (15.0 ft)		6.0 m (20.0 ft)		7.5 m (25.0 ft)		Capacity		Reach m (ft)	
														
6.0 m (20.0 ft)	kg							*2100	*2100			*2570	1480	7.46
	lb							*4630	*4630			*5670	3260	(24.5)
4.5 m (15.0 ft)	kg							*2710	2200			*2590	1210	8.14
	lb							*5970	4850			*5710	2670	(26.7)
3.0 m (10.0 ft)	kg											*2640	1080	8.46
	lb											*5820	2380	(27.8)
1.5 m (5.0 ft)	kg											2640	1040	8.46
	lb											5820	2290	(27.8)
Ground	kg	*3780	*3780	*9530	5580	*5830	2920	*4280	1840	*1820	1250	2780	1100	8.15
Line	lb	*8330	*8330	*21010	12300	*12850	6440	*9440	4060	*4010	2760	6130	2430	(26.7)
-1.5 m (-5.0 ft)	kg	*5830	*5830	*9890	5450	*6250	2810	*4490	1780			3210	1280	7.48
	lb	*12850	*12850	*21800	12020	*13780	6190	*9900	3920			7080	2820	(24.5)
-3.0 m (-10.0 ft)	kg	*8470	*8470	*9150	5500	*5950	2820	*3320	1810			*3390	1750	6.31
	lb	*18670	*18670	*20170	12130	*13120	6220	*7320	3990			*7470	3860	(20.7)
-4.5 m (-15.0 ft)	kg													
	lb													







R140W-9 ADJUSTABLE BOOM

 Rating over-front  Rating over-side or 360 degree

Boom : 4.9 m (16' 9") / Arm : 1.9 m (6' 3") / Bucket : 0.58 m³ (0.76 yd³) SAE heaped / With rear dozer blade down and 1,800kg Counterweight

Load point height m (ft)	Load radius				At max. reach					
	3.0 m (10.0 ft)		4.5 m (15.0 ft)		6.0 m (20.0 ft)		Reach m (ft)			
										
6.0 m (20.0 ft)	kg			*2960	*2960			*2910	1790	6.70
	lb			*6530	*6530			*6420	3950	(22.0)
4.5 m (15.0 ft)	kg	*4240	*4240	*3500	*3500	*3230	2110	*3010	1410	7.46
	lb	*9350	*9350	*7720	*7720	*7120	4650	*6640	3110	(24.5)
3.0 m (10.0 ft)	kg			*4520	3250	*3630	2020	*3080	1250	7.81
	lb			*9960	7170	*8000	4450	6790	2760	(25.6)
1.5 m (5.0 ft)	kg			*5550	2980	*4110	1900	3040	1220	7.81
	lb			*12240	6570	*9060	4190	6700	2690	(25.6)
Ground	kg	*6150	5410	*6150	2840	*4450	1830	3260	1310	7.47
Line	lb	*13560	11930	*13560	6260	*9810	4030	7190	2890	(24.5)
-1.5 m (-5.0 ft)	kg	*9320	5480	*6170	2820	*4410	1820	*3580	1590	6.72
	lb	*20550	12080	*13600	6220	*9720	4010	*7890	3510	(22.0)
-3.0 m (-10.0 ft)	kg			*5400	2920					
	lb			*11900	6440					

Boom : 4.9 m (16' 9") / Arm : 2.1 m (6' 11") / Bucket : 0.58 m³ (0.76 yd³) SAE heaped / With rear dozer blade down and 1,800kg Counterweight

Load point height m (ft)	Load radius				At max. reach					
	3.0 m (10.0 ft)		4.5 m (15.0 ft)		6.0 m (20.0 ft)		Reach m (ft)			
										
6.0 m (20.0 ft)	kg			*2770	*2770			*2780	1680	6.91
	lb			*6110	*6110			*6130	3700	(22.7)
4.5 m (15.0 ft)	kg			*3300	*3300	*3090	2110	*2880	1330	7.65
	lb			*7280	*7280	*6810	4650	*6350	2930	(25.1)
3.0 m (10.0 ft)	kg			*4320	3240	*3500	2000	2950	1180	7.99
	lb			*9520	7140	*7720	4410	6500	2600	(26.2)
1.5 m (5.0 ft)	kg			*5380	2950	*4000	1870	2910	1140	7.99
	lb			*11860	6500	*8820	4120	6420	2510	(26.2)
Ground	kg	*6320	5320	*6040	2790	*4370	1790	3110	1220	7.66
Line	lb	*13930	11730	*13320	6150	*9630	3950	6860	2690	(25.1)
-1.5 m (-5.0 ft)	kg	*9370	5370	*6140	2760	*4400	1770	*3480	1470	6.93
	lb	*20660	11840	*13540	6080	*9700	3900	*7670	3240	(22.7)
-3.0 m (-10.0 ft)	kg			*5500	2840					
	lb			*12130	6260					

1. Lifting capacity is based on SAE J1097, ISO 10567.

2. Lifting capacity of the Robex Series does not exceed 75% of the tipping load with the machine on firm, level ground or 87% of full hydraulic capacity.

3. The load point is a hook located on the back of the bucket.











4. (*) indicates the load limited by hydraulic capacity.

Lifting Capacity

R140W-9 ADJUSTABLE BOOM

 Rating over-front  Rating over-side or 360 degree

Boom : 4.9 m (16' 9") / Arm : 2.5 m (8' 2") / Bucket : 0.58 m³ (0.76 yd³) SAE heaped / With rear dozer blade down and 1,800kg Counterweight

Load point height m (ft)	Load radius								At max. reach						
	3.0 m (10.0 ft)		4.5 m (15.0 ft)		6.0 m (20.0 ft)		7.5 m (25.0 ft)		Capacity		Reach m (ft)				
															
6.0 m (20.0 ft)	kg									*2560	2180		*2580	1470	7.39
	lb									*5640	4810		*5690	3240	(24.2)
4.5 m (15.0 ft)	kg									*2900	*2900		*2800	2140	8.08
	lb									*6390	*6390		*5910	2600	(26.5)
3.0 m (10.0 ft)	kg									*5850	*5850		*3940	3290	8.40
	lb									*12900	*12900		*8690	7250	(27.6)
1.5 m (5.0 ft)	kg									*6100	5580		*5080	2980	8.40
	lb									*13450	12300		*11200	6570	(27.6)
Ground	kg	*6370	5300	*5870	2780	*4240	1770			*6370	5300		*5870	2780	8.09
Line	lb	*14040	11680	*12940	6130	*9350	3900			*14040	11680		*12940	6130	(26.5)
-1.5 m (-5.0 ft)	kg	*9040	5290	*6120	2720	*4400	1730			*9040	5290		*6120	2720	7.41
	lb	*19930	11660	*13490	6000	*9700	3810			*19930	11660		*13490	6000	(24.3)
-3.0 m (-10.0 ft)	kg									*8660	5430		*5730	2770	
	lb									*19090	11970		*12630	6110	

1. Lifting capacity is based on SAE J1097, ISO 10567.

2. Lifting capacity of the Robex Series does not exceed 75% of the tipping load with the machine on firm, level ground or 87% of full hydraulic capacity.

3. The load point is a hook located on the back of the bucket.

4. (*) indicates the load limited by hydraulic capacity.